

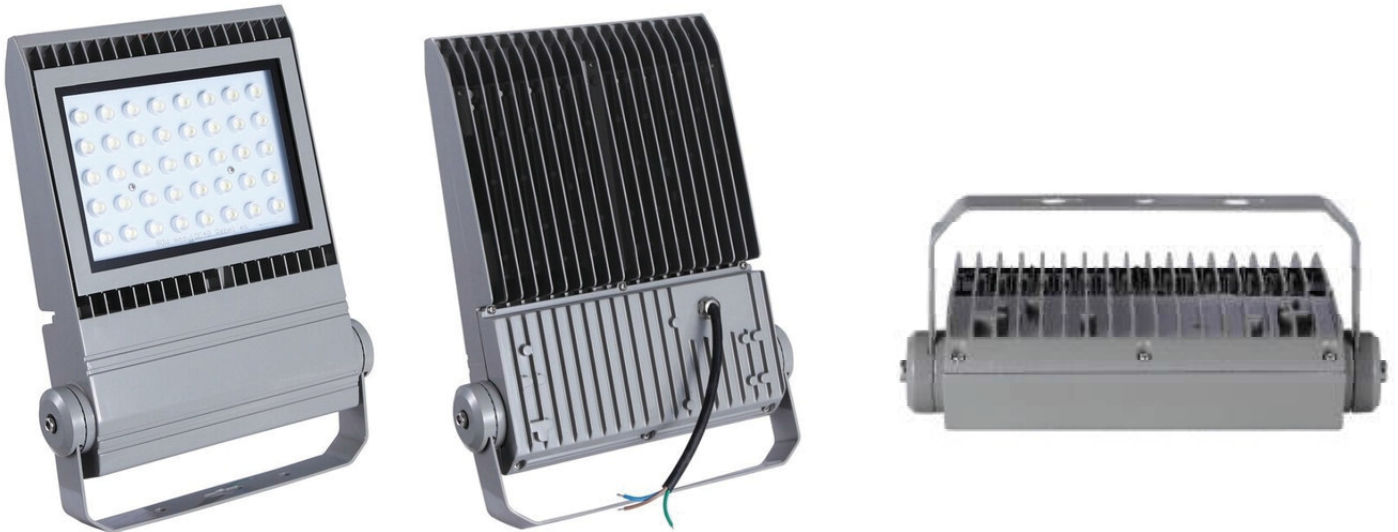

## Module LED Flood Light 80W



### 1 Features

- 1 Unlike a traditional LED flood light which has a heat sink on the back of the lamp, our latest model has a special fin type heat sink built into the case. This makes the lamp lighter and provides for superior heat dissipation.
- 2 The LED driver is installed away from the heat sink. This separation of the LED driver creates a lower heat working environment giving the lamp a longer life span.
- 3 IP67
- 4 Beautiful appearance using Philips LEDs with super luminous 120+ LM/W.
- 5 A Mean Well LED driver. With 3 year guarantee.



## 2 Application of the lamp.

For outdoor lighting, such as architecture, industrial area, factory, gym, garden, sea port and so on.

## 3 Dimensions of the lamp.

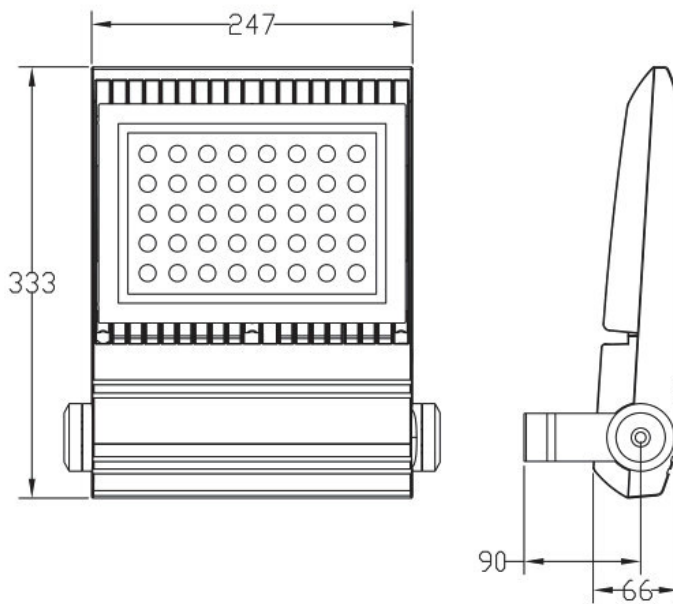

## 4 Main technical parameters

Item No.	CCT	Ra	Lumens	Input Wattage	Lamp power
WX-FG-M-80W	5000-5650K	≥70	7950	AC100-277V	88±6 W
LED: PHILIPS REBEL					
Storage Temperature : - 40 ~ 50°C					



### 5 Light distribution parameters

10degree

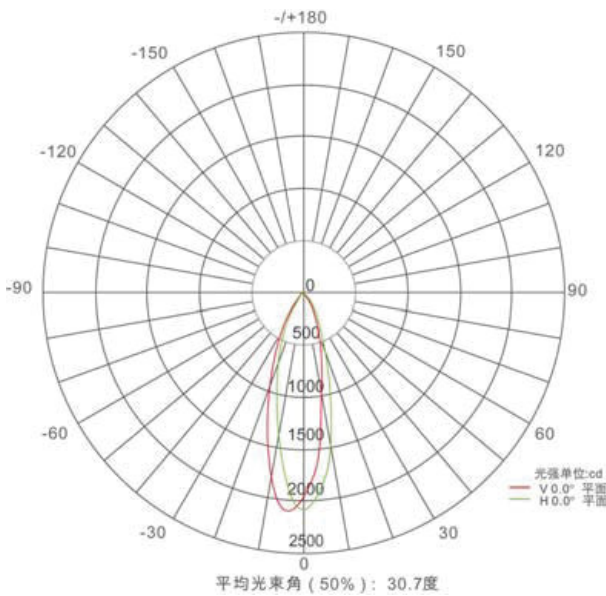
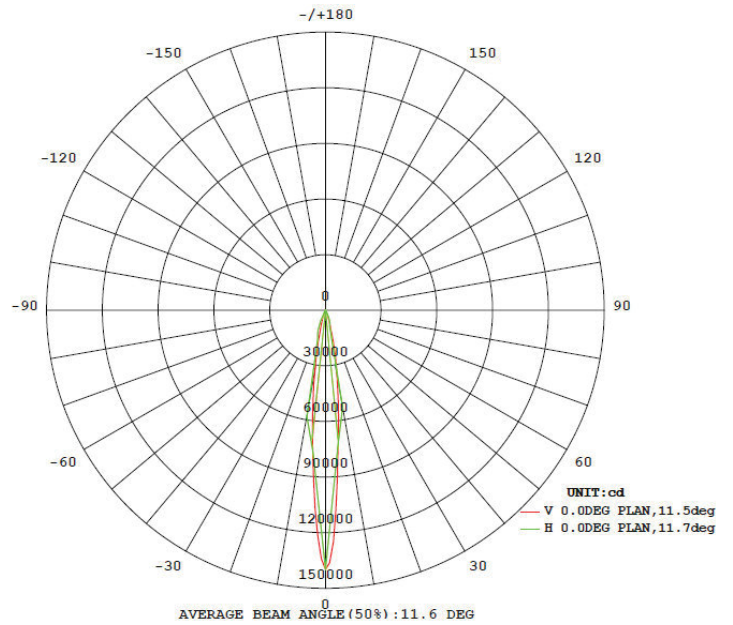

30degree

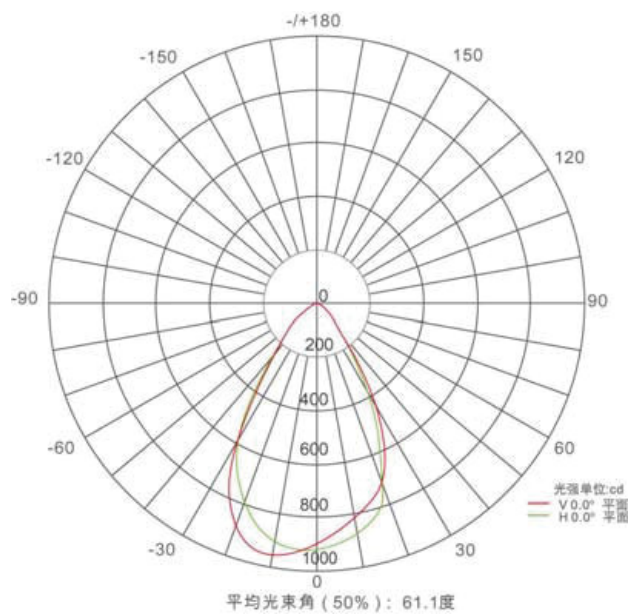

60degree

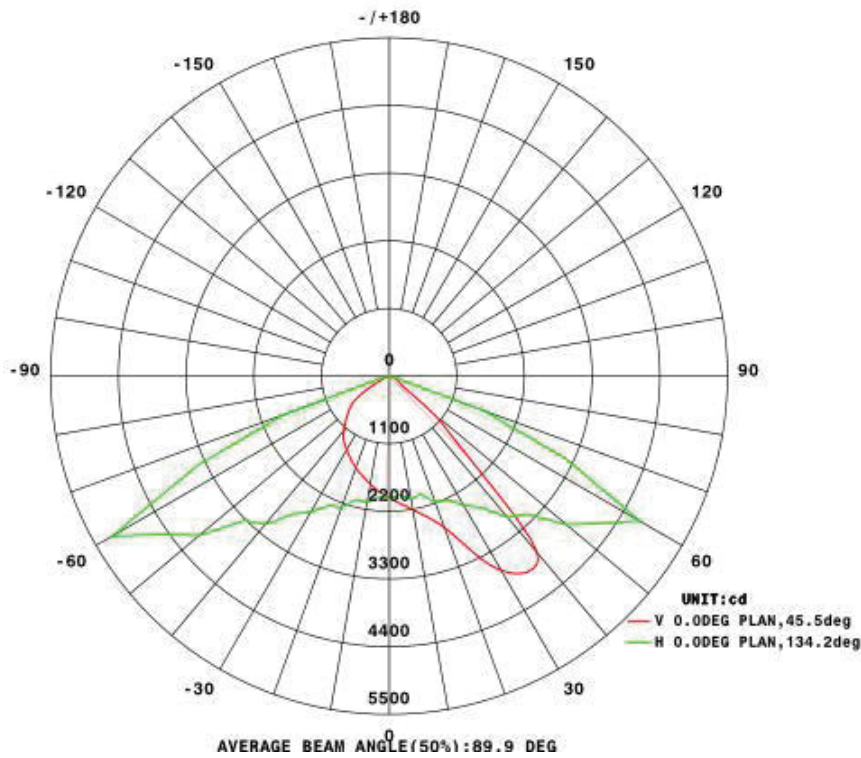

60x135 degree

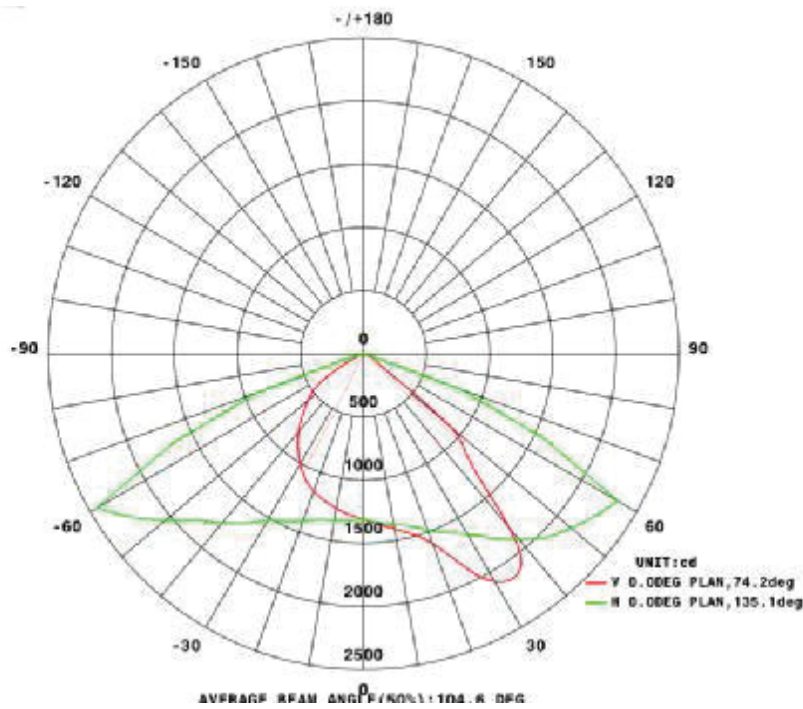

85x135degree



## 6 Package

Net weight/pc	Gross weight/pc	Carton	Inner box	Quantity/Carton
4.6KG	5.2KG	432*330*548mm	414*318*132mm	4pcs

## 7 Instructions for installation

- Cut off the power and make sure the wall can support the weight of the lamp before installing.
- Make sure the lamp is secure and correctly installed.
- Do not use the lamp in any area near flammable fumes or gases.
- Do not cover the lamp.
- Be careful and connect the ground wire.
- Altering the product or installing it incorrectly will void the warranty.

## 8 Instructions for installation.

